



INDIVIDUAL DATA SHEETS

LC-R064R5P* 1

FOR MAIN AND STANDBY POWER SUPPLIES.
 EXPECTED TRICKLE DESIGN LIFE: 6 – 9 YEARS AT 20°C
 ACCORDING TO EUROBAT.

DIMENSIONS (MM)

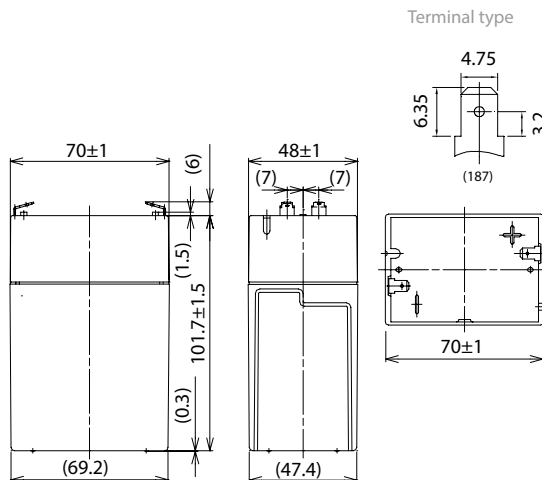

Contents indicated (including the recycle marking, etc.) are subject to change without notice. Battery case resin: standard (UL94 HB)

Specifications		LC-R064R5P* 1
Nominal voltage (V)		6
Nominal capacity	20 hours rate (Ah)	4.5
Dimensions	Length (mm)	48
	Width (mm)	70
	Total height (mm)	108
Approx. mass (kg)		0.70
Terminal type		Faston 187
Capacity (25°C)	20 hours rate (Ah)	4.5
	10 hours rate (Ah)	4.1
	3 hours rate (Ah)	3.6
	1 hour rate (Ah)	3.1
Impedance (mΩ)	Fully charged battery (25°C)	20
	40°C	102
Temperature dependency of capacity (%) – 20 hours rate	25°C	100
	0°C	85
	-15°C	65
	Remaining capacity (25°C)	After 3 months (%)
After 6 months (%)		82
After 12 months (%)		64

DURATION OF DISCHARGE VS. DISCHARGE CURRENT

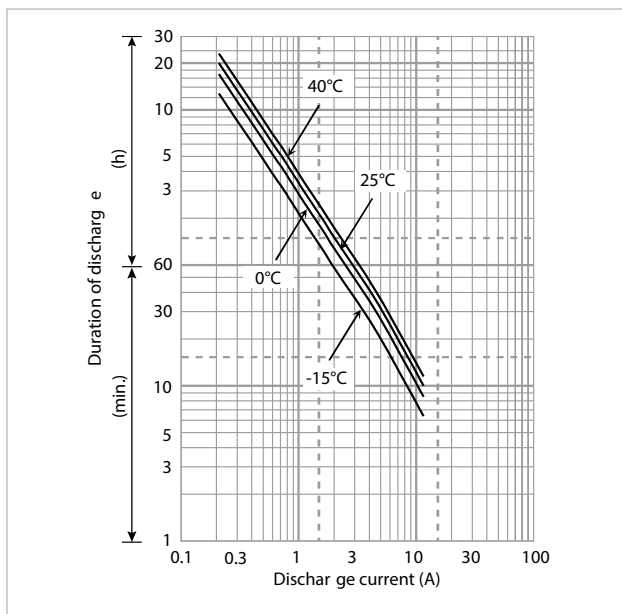

WATT TABLE (25°C)

(Wattage/battery)

Cut-off	3min.	5min.	10min.	15min.	20min.	30min.	45min.	1h	1.5h	2h	3h	4h	5h	6h	10h	20h
4.80V	135.0	107	69.7	53.2	44.6	33.3	23.5	18.8	12.9	9.99	7.44	5.71	4.72	3.79	2.51	1.36
4.95V	125.0	100	68.3	52.8	43.9	32.9	23.3	18.6	12.7	9.92	7.40	5.68	4.68	3.78	2.50	1.36
5.10V	116.0	93.7	66.5	51.8	43.1	32.5	23.1	18.4	12.4	9.66	7.33	5.64	4.64	3.75	2.48	1.35
5.25V	103.0	84.0	61.6	48.2	41.0	31.8	22.7	18.0	12.1	9.32	7.21	5.60	4.60	3.70	2.46	1.35
5.40V	86.9	74.2	55.0	44.9	39.9	30.7	22.4	17.7	11.8	8.88	7.07	5.53	4.49	3.64	2.44	1.34

AMPERE TABLE (25°C)

(Ampere/battery)

Cut-off	3min.	5min.	10min.	15min.	20min.	30min.	45min.	1h	1.5h	2h	3h	4h	5h	6h	10h	20h
4.80V	24.3	19.1	12.4	9.25	7.69	5.69	4.00	3.19	2.19	1.69	1.25	0.956	0.788	0.633	0.419	0.227
4.95V	22.6	17.9	12.2	9.19	7.56	5.63	3.98	3.16	2.14	1.68	1.24	0.950	0.781	0.630	0.417	0.226
5.10V	20.8	16.8	11.9	9.00	7.44	5.56	3.94	3.13	2.10	1.63	1.23	0.944	0.775	0.625	0.413	0.226
5.25V	18.5	15.1	11.0	8.38	7.06	5.44	3.88	3.06	2.06	1.58	1.21	0.938	0.769	0.618	0.411	0.225
5.40V	15.6	13.3	9.81	7.81	6.88	5.25	3.81	3.00	2.00	1.50	1.19	0.925	0.750	0.608	0.406	0.224

All mentioned values are average values

*1 This battery is also available with a flame-retardant battery case resin (UL94 V-0): LC-V064R5P.

LC-R064R5P* 1

CHARGING METHOD (25°C)

Cycle use	Control voltage: 7.25V - 7.45V Initial current: 1.80A or smaller
-----------	---

CUT-OFF VOLTAGE

Discharge current	0.225A - 0.900A	0.900A - 2.25A	2.25A - 4.50A	4.50A - 9.00A	9.00A - 13.5A
Cut-off voltage	5.25V	5.10V	4.95V	4.65V	4.35V

CYCLE LIFE VS. DEPTH OF DISCHARGE (ACC. IEC 61056)

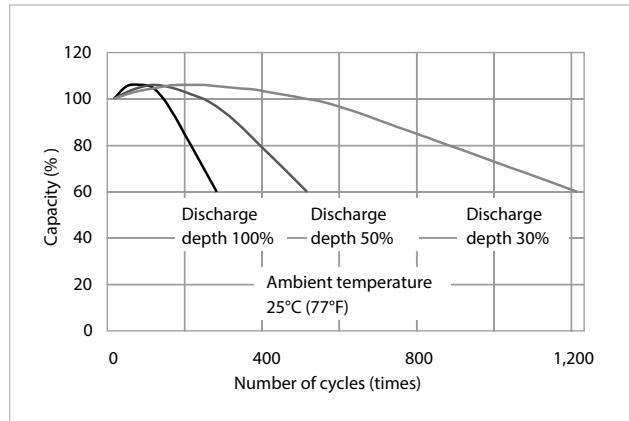

RESIDUAL CAPACITY TEST RESULT

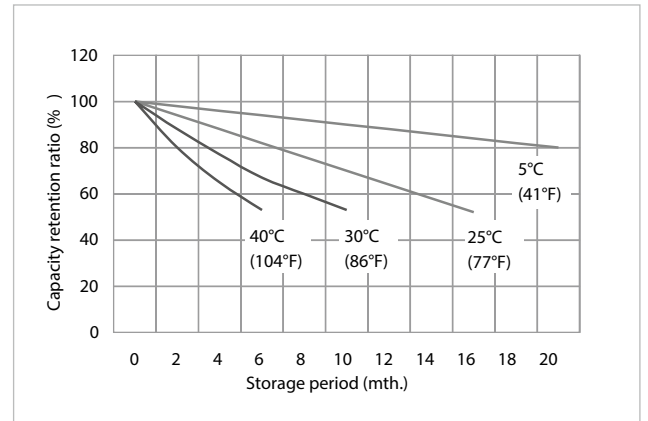

CONSTANT-VOLTAGE CONSTANT-CURRENT CHARGE CHARACTERISTICS FOR CYCLE USE

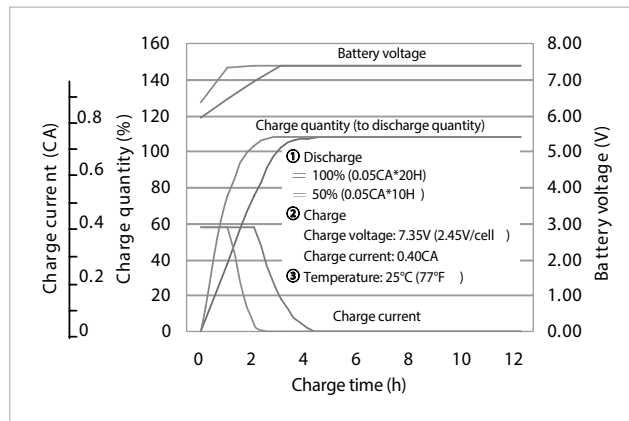

DISCHARGE CAPACITY BY TEMPERATURE AND BY DISCHARGE CURRENT

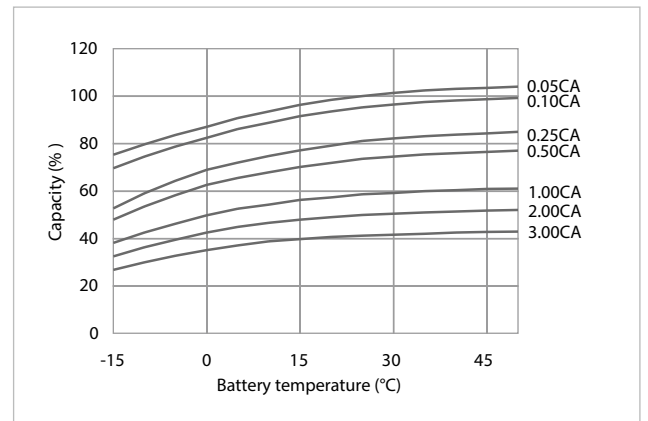

DISCHARGE CHARACTERISTICS

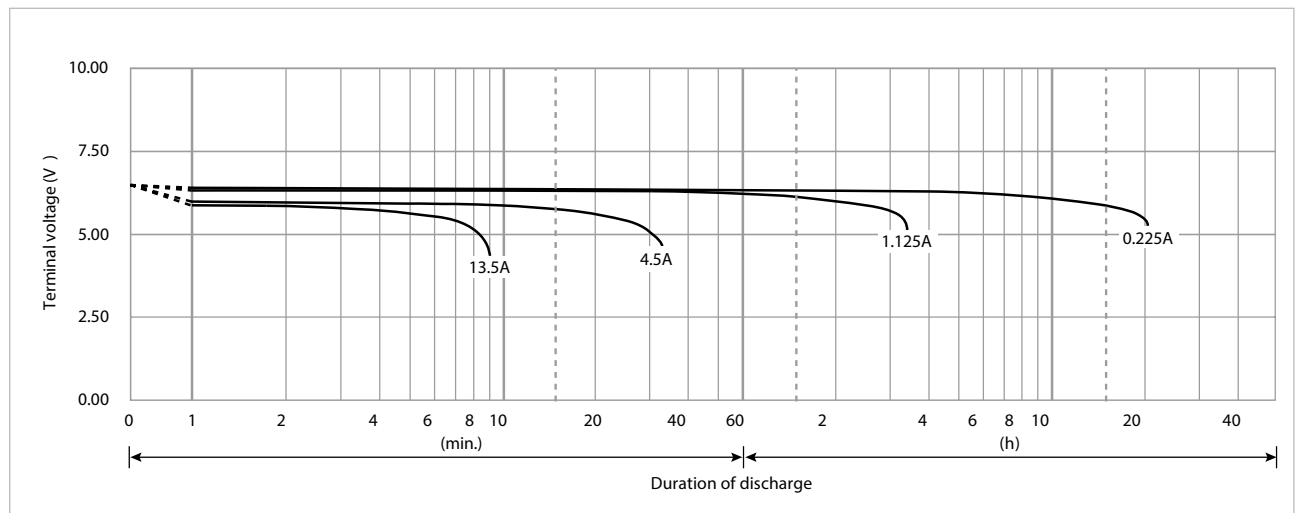

*1 This battery is also available with a flame-retardant battery case resin (UL94 V-0): LC-V064R5P.